

## ➔ ASME B16.47 series B flange

### ▶ Class 400 Welding Neck Flanges

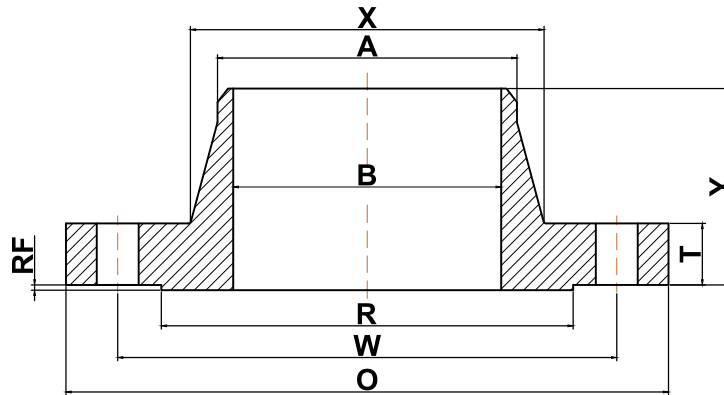

Nominal Pipe Size	Outside Diameter (O)	Bolt Circle (W)	Raised Face Diameter (R)	Number of Holes	Diameter of Holes	Bore (B)	Top of Hub (A)	Hub Diameter (X)	Minimum Fillet Radius (r)	Minimum Thickness (T)	Length Thru Hub (Y)	Approximate Weight (lbs)
26	33.50	30.75	28.00	28	1.50	Specified by purchaser	26.00	27.12	0.44	3.50	5.88	360
28	36.00	33.00	30.00	24	1.62	Specified by purchaser	28.00	29.12	0.50	3.75	6.25	450
30	38.25	35.25	32.25	28	1.62	Specified by purchaser	30.00	31.25	0.50	4.00	6.69	530
32	40.75	37.50	34.38	28	1.75	Specified by purchaser	32.00	33.25	0.50	4.25	7.06	635
34	42.75	39.50	36.50	32	1.75	Specified by purchaser	34.00	35.38	0.56	4.38	7.38	690
36	45.50	42.00	38.62	28	1.88	Specified by purchaser	36.00	37.50	0.56	4.69	7.88	855
38	47.50	44.00	40.75	32	1.88	Specified by purchaser	38.00	39.50	0.56	4.88	8.12	935
40	50.00	46.25	43.00	32	2.00	Specified by purchaser	40.00	41.50	0.56	5.12	8.50	1090
42	52.00	48.25	45.00	32	2.00	Specified by purchaser	42.00	43.62	0.56	5.25	8.81	1190
44	54.50	50.50	47.25	32	2.12	Specified by purchaser	44.00	45.62	0.56	5.50	9.18	1375
46	56.75	52.75	49.50	36	2.12	Specified by purchaser	46.00	47.75	0.56	5.75	9.62	1525
48	59.50	55.25	51.50	28	2.38	Specified by purchaser	48.00	49.88	0.56	6.00	10.12	1790
50	61.75	57.50	53.62	32	2.38	Specified by purchaser	50.00	52.00	0.56	6.19	10.56	1950
52	63.75	59.50	55.62	32	2.38	Specified by purchaser	52.00	54.00	0.56	6.38	10.88	2125
54	67.00	62.25	57.88	28	2.62	Specified by purchaser	54.00	56.12	0.56	6.69	11.38	2565
56	69.00	64.25	60.12	32	2.62	Specified by purchaser	56.00	58.25	0.56	6.88	11.75	2710
58	71.00	66.25	62.12	32	2.62	Specified by purchaser	58.00	60.25	0.56	7.00	12.06	3230
60	74.25	69.00	64.38	32	2.88	Specified by purchaser	60.00	62.38	0.56	7.31	12.56	3820

(a) All dimensions are in inches

(b) These flanges will be furnished with a 1/4" raised face unless otherwise specified.